

ANEXO XXIV - FIGURAS

FIGURA Nº 1



FIGURA Nº 2



FIGURA Nº 3

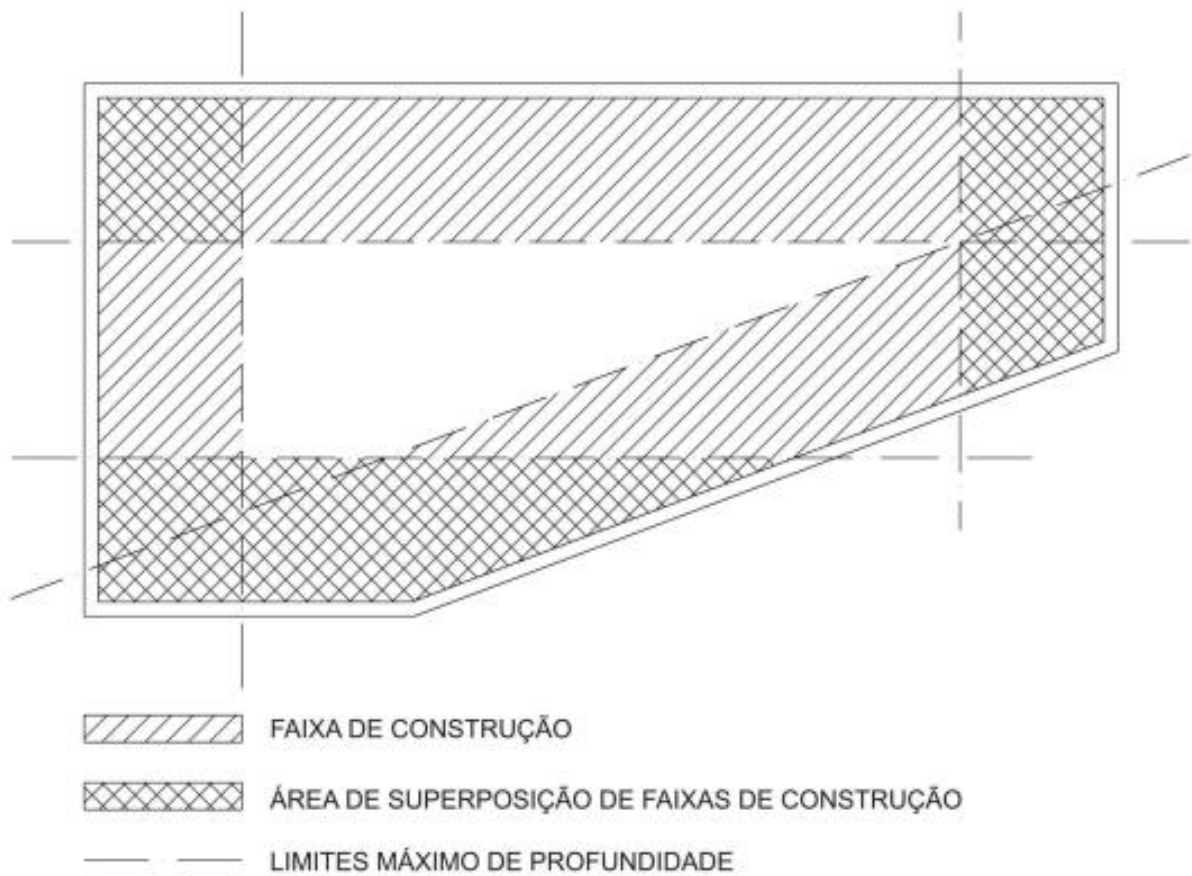
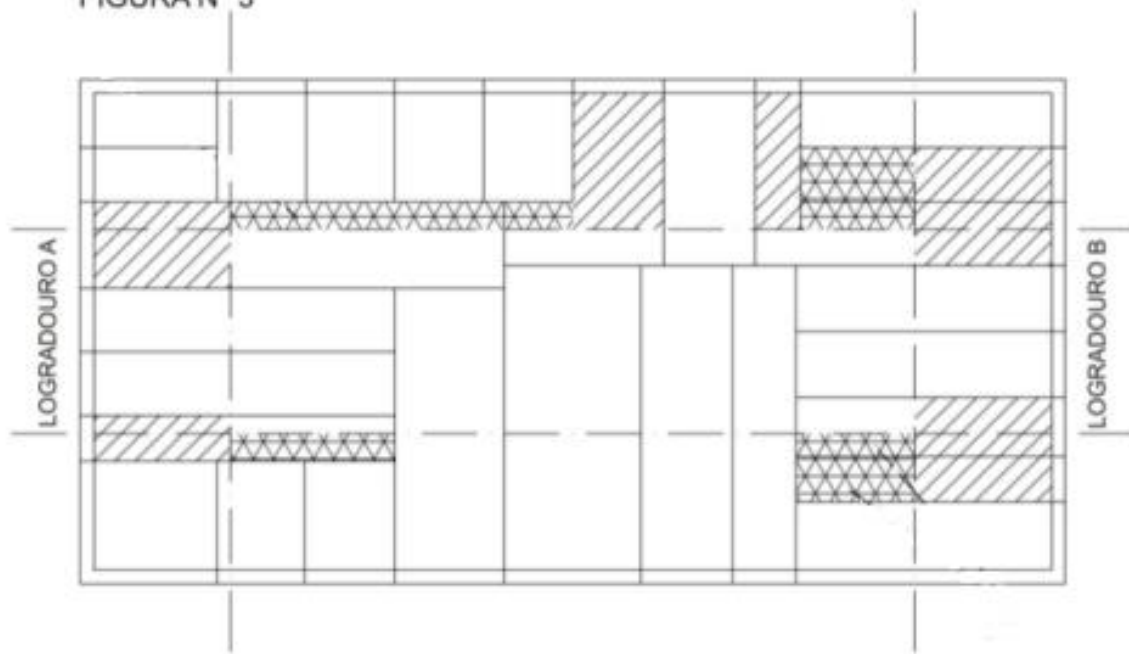

ÁREA AEDIFICANDI



ÁREA NON AEDIFICANDI ENCRAVADA ENTRE  
O LIMITE DE PROFUNDIDADE DE CONSTRUÇÃO  
E AS DIVISAS DE LOTES CONTÍGUOS



LIMITES MÁXIMOS DE PROFUNDIDADE

FIGURA Nº 4



FIGURA Nº 5



FIGURA Nº 6

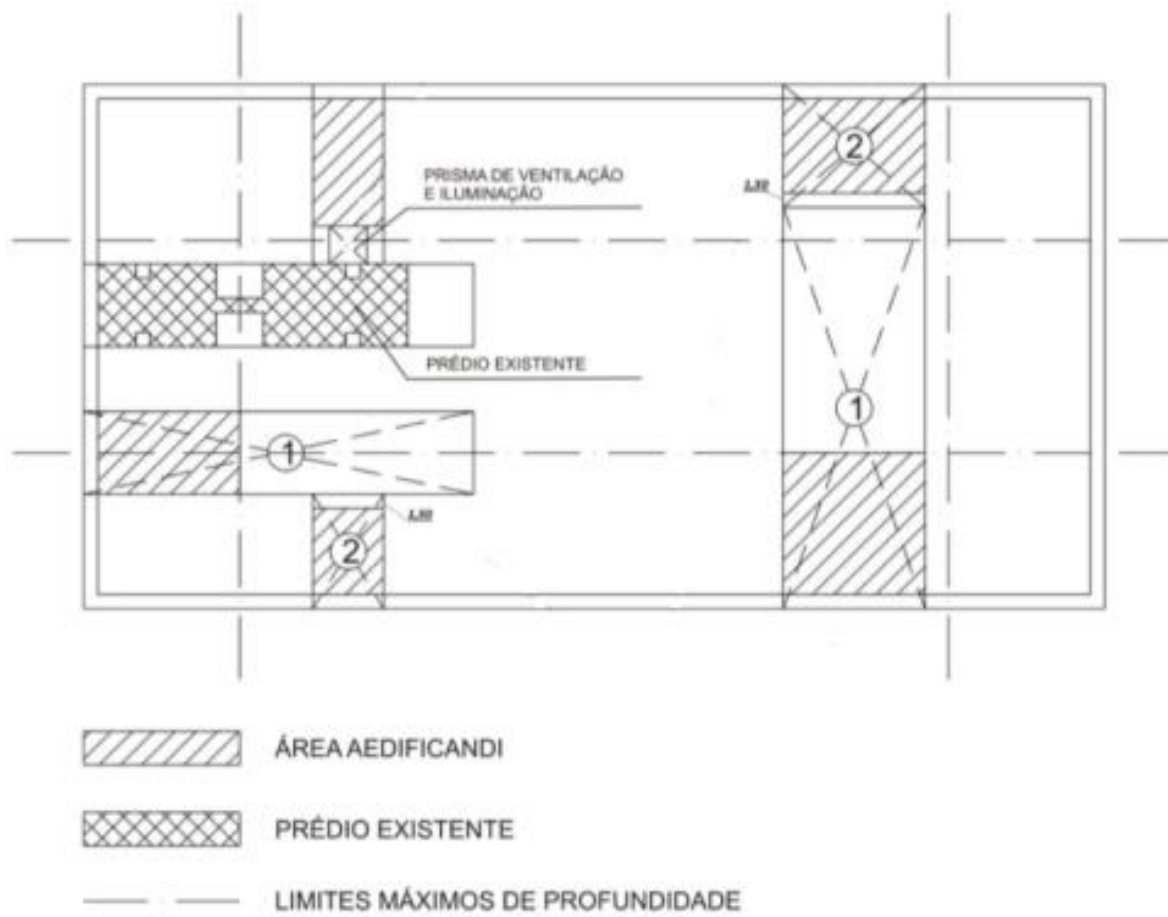

FIGURA Nº 7

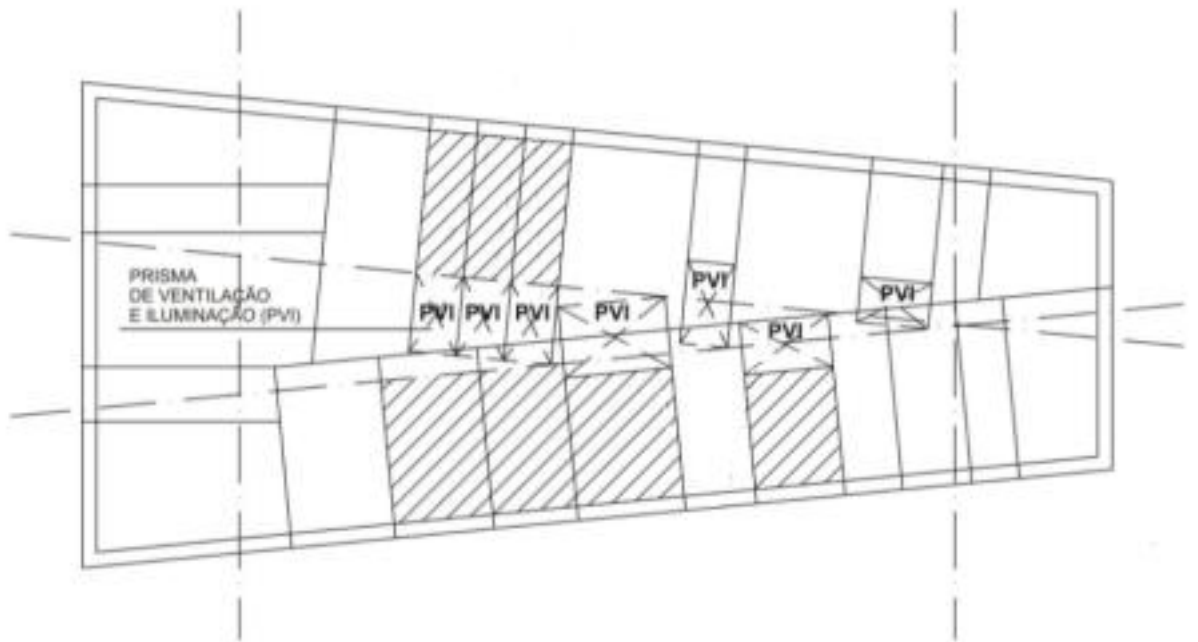

FIGURA Nº 8

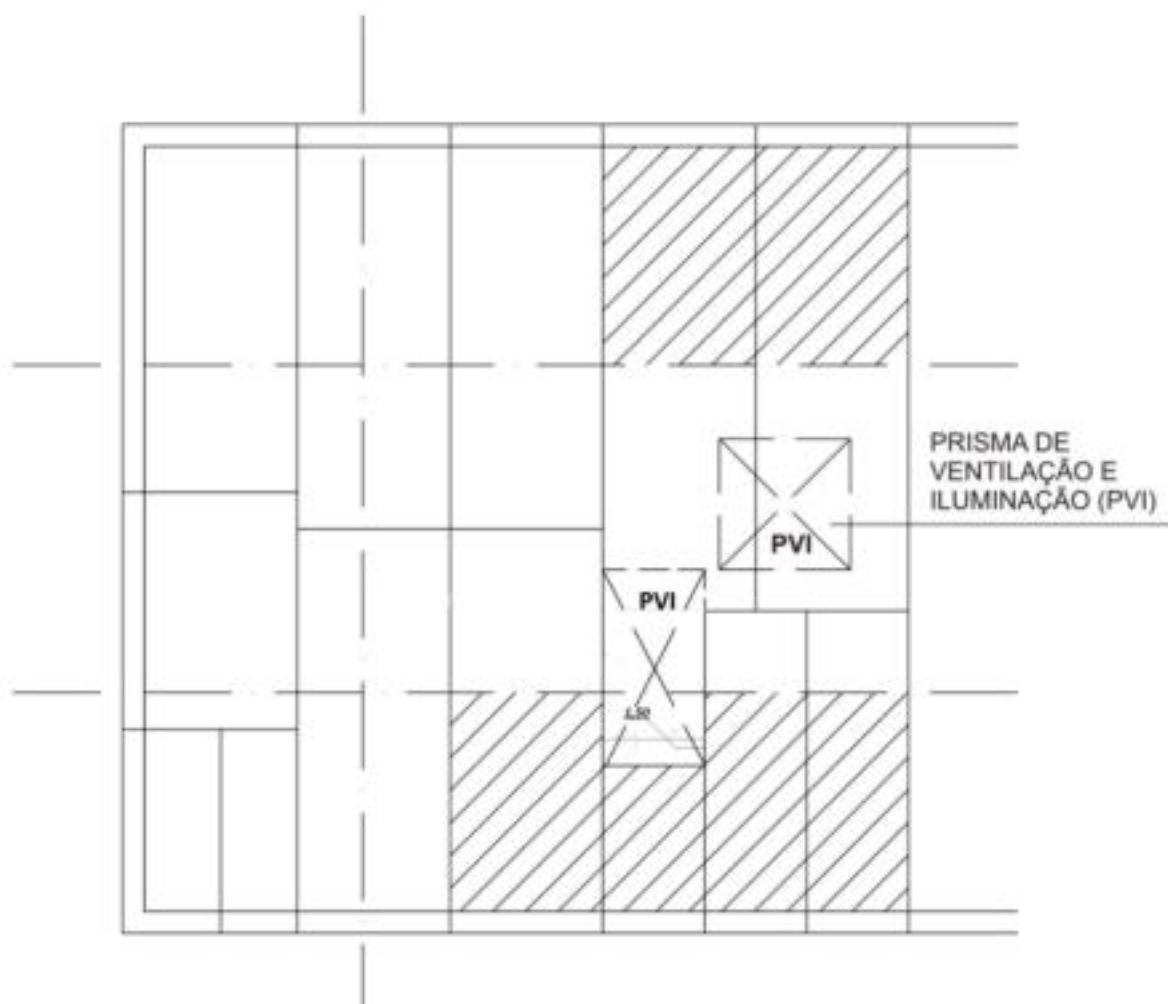

FIGURA Nº 9

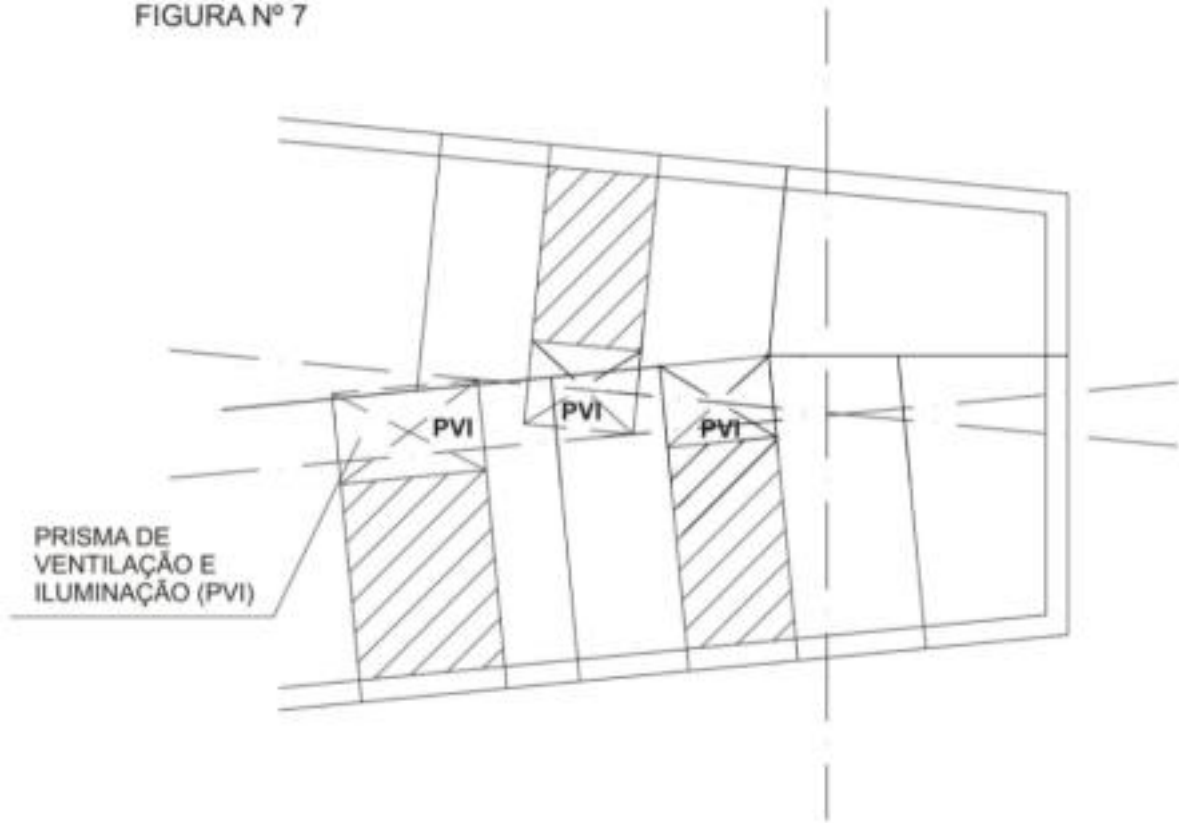
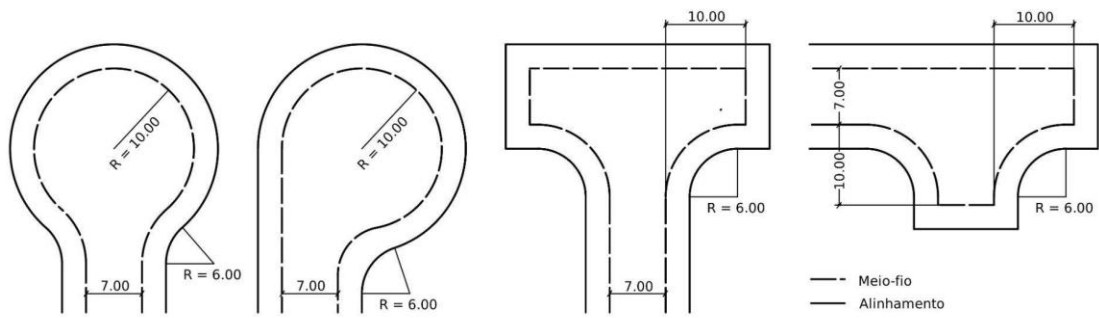